

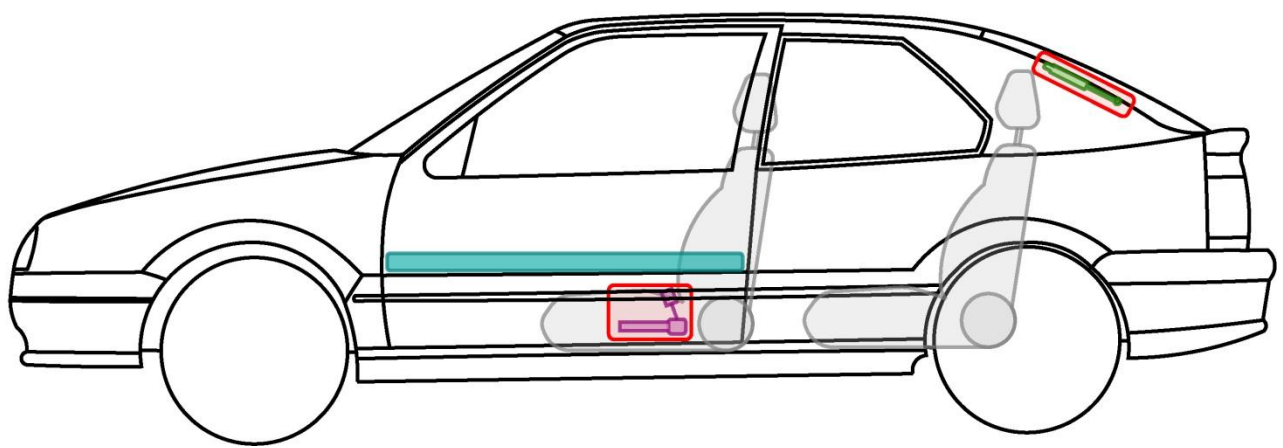

19 3-Türer

TYP: C53/X53, 1994-1995

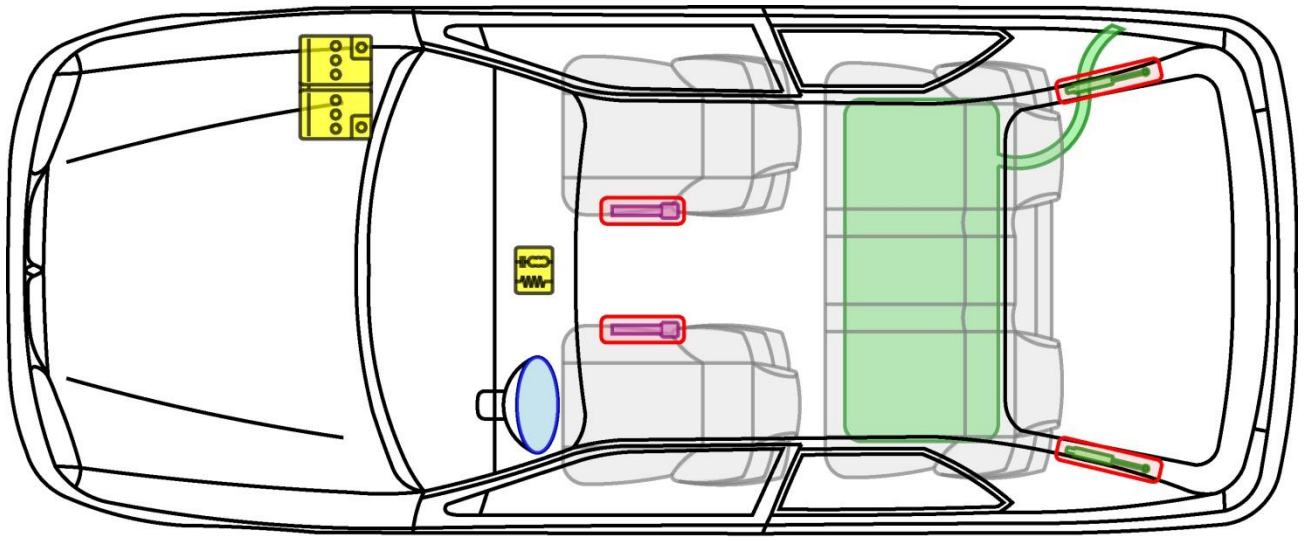

Legende

	Airbag		Karosserie-verstärkung		Steuergerät
	Gas-generator		Überroll-schutz		Batterie
	Gurt-straffer		Gasdruck-dämpfer		Kraftstoff-tank



19 4-Türer

TYP: L53/X53, 1994-1995

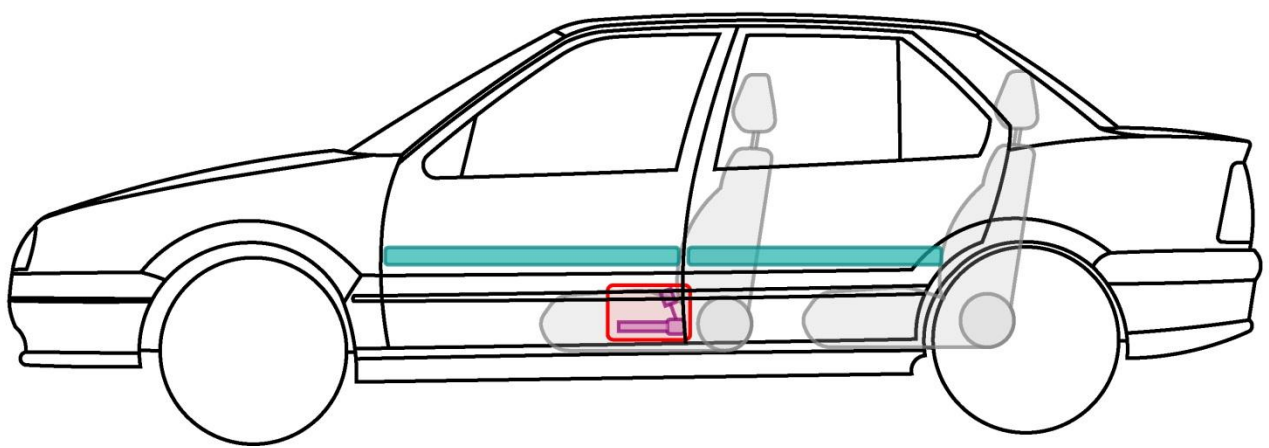
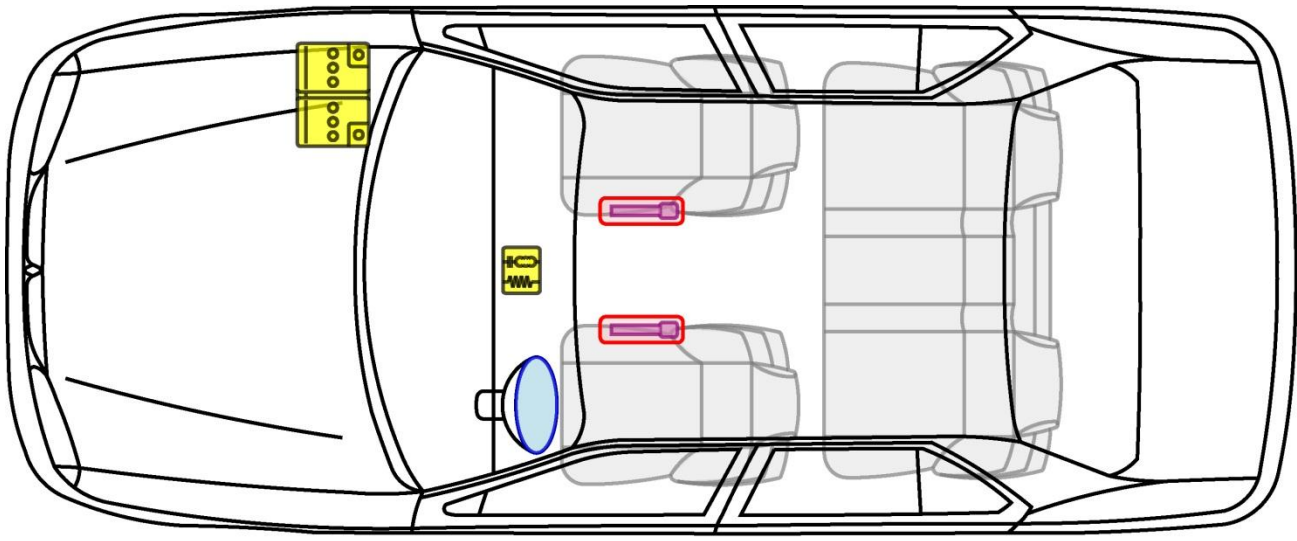

Legende

	Airbag		Karosserie-verstärkung		Steuergerät
	Gas-generator		Überroll-schutz		Batterie
	Gurt-straffer		Gasdruck-dämpfer		Kraftstoff-tank









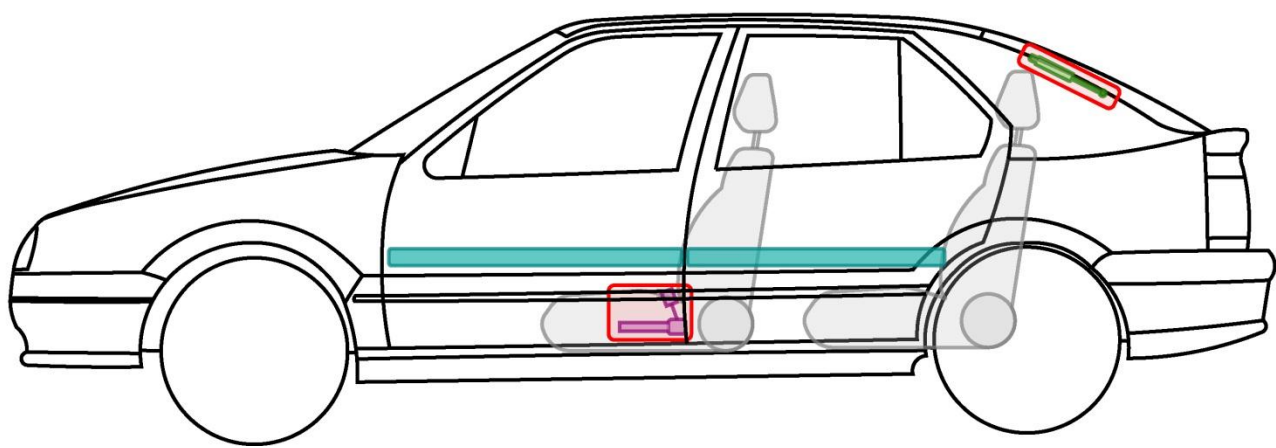
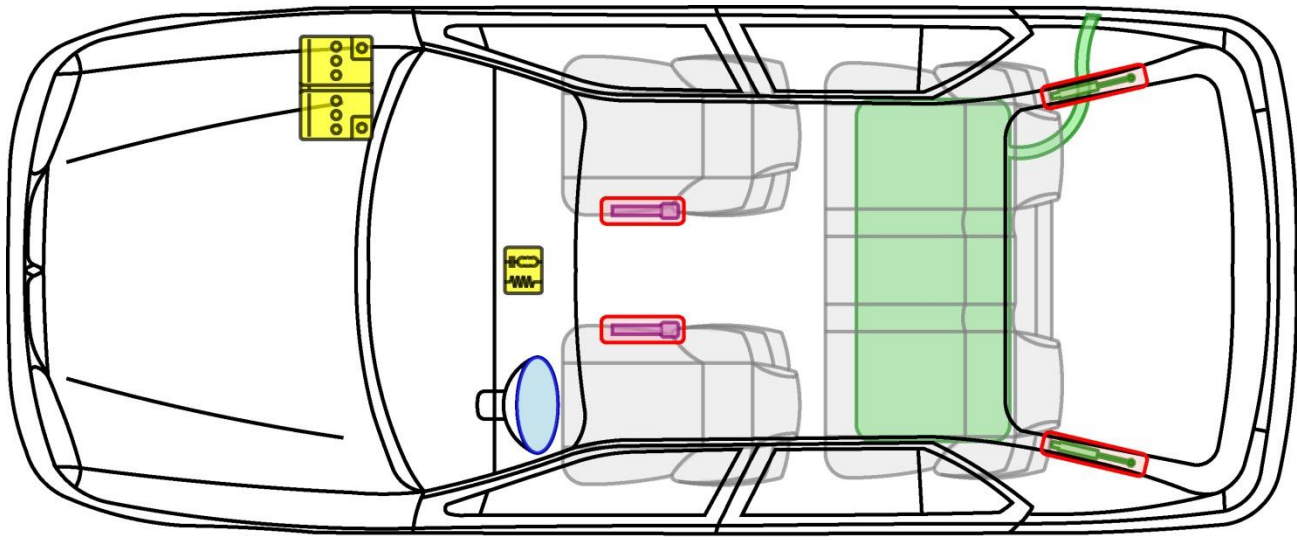



19 5-Türer

TYP: B53/X53, 1994-1996

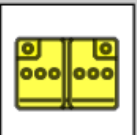





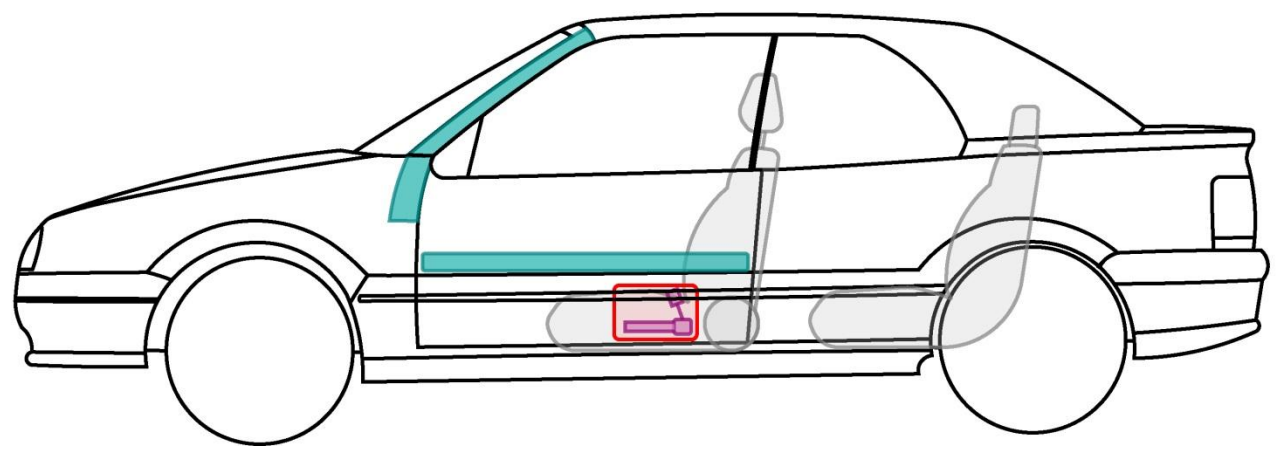
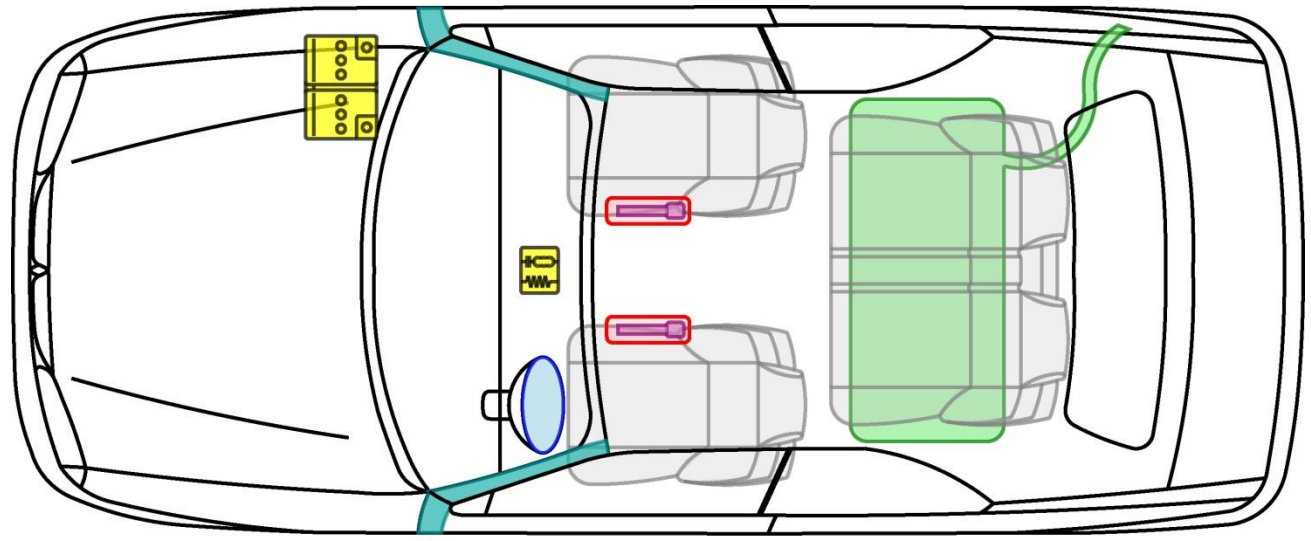

Legende

	Airbag		Karosserie-verstärkung		Steuergerät
	Gas-generator		Überroll-schutz		Batterie
	Gurt-straffer		Gasdruck-dämpfer		Kraftstoff-tank



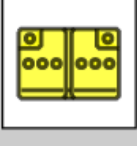
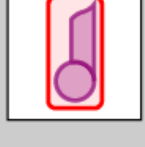

Legende

	Airbag		Karosserie- verstärkung		Steuergerät
	Gas- generator		Überroll- schutz		Batterie
	Gurt- straffer		Gasdruck- dämpfer		Kraftstoff- tank